



清华大学
TSINGHUA UNIVERSITY



ECal Production Database

Yulei Li

liyulei18@tsinghua.org.cn

Department of Engineering Physics, Tsinghua University

2020/9/2



Storage allocation of ECal data

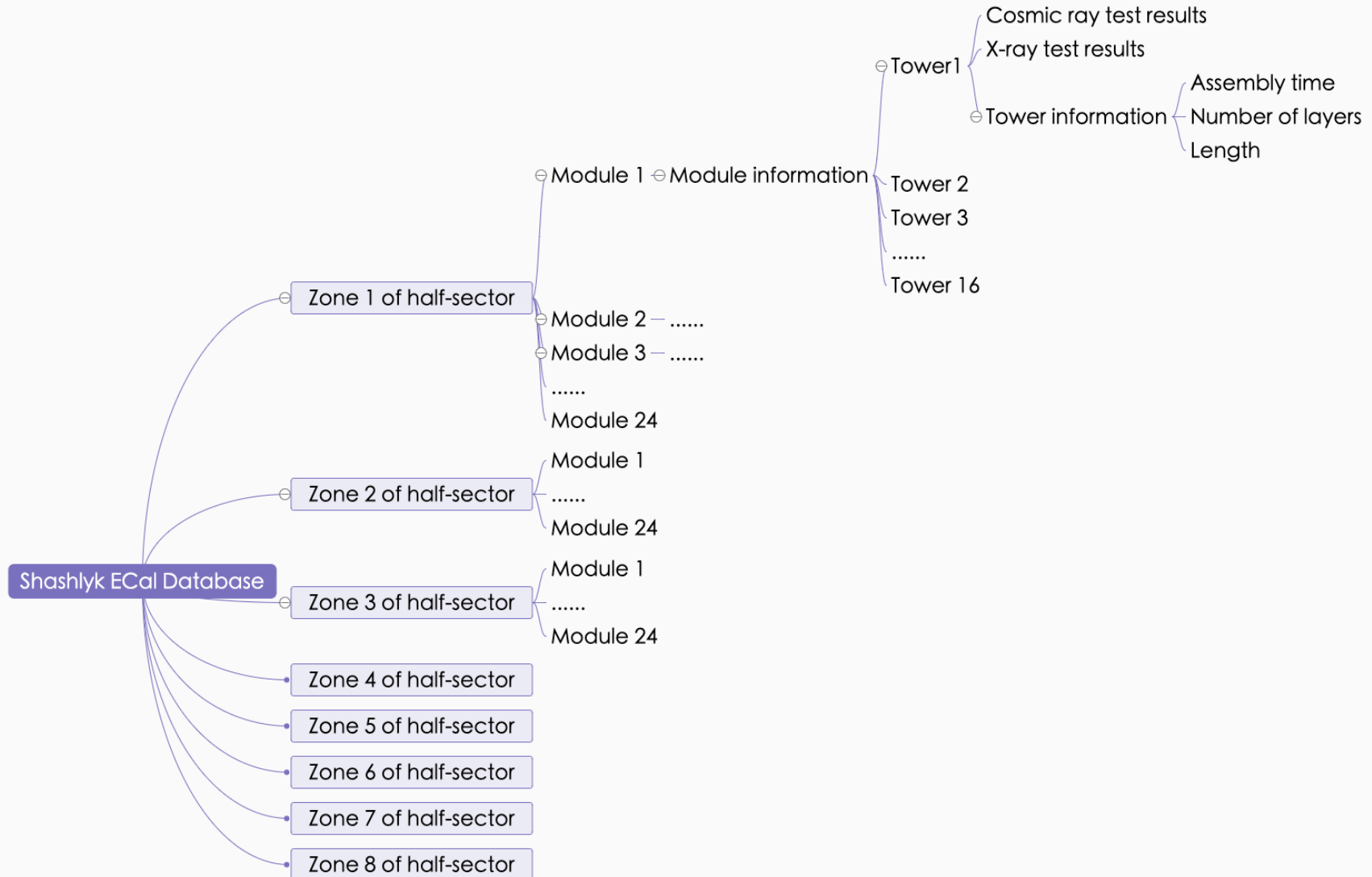



? Assembly time

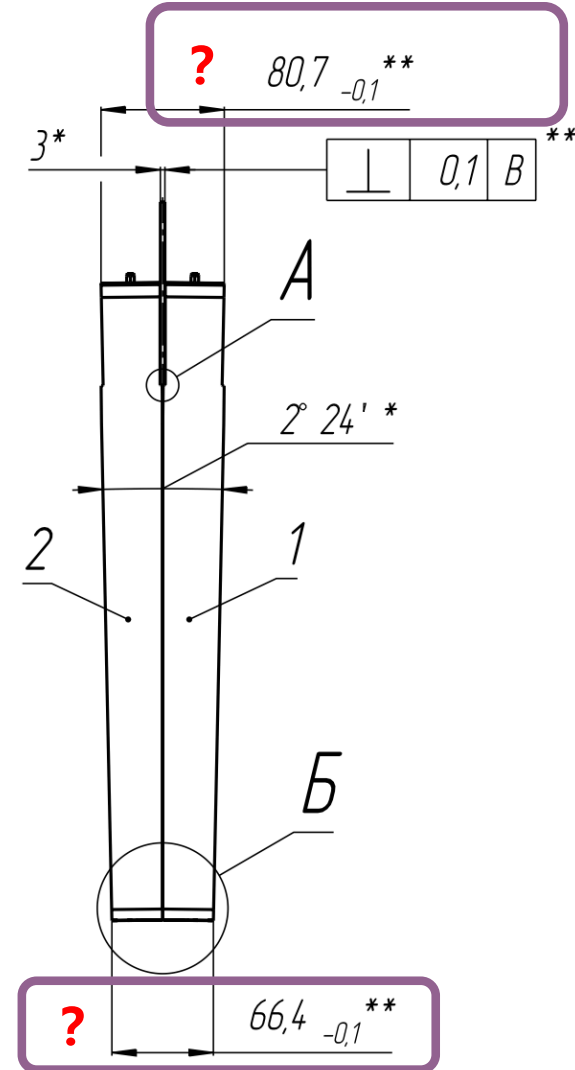
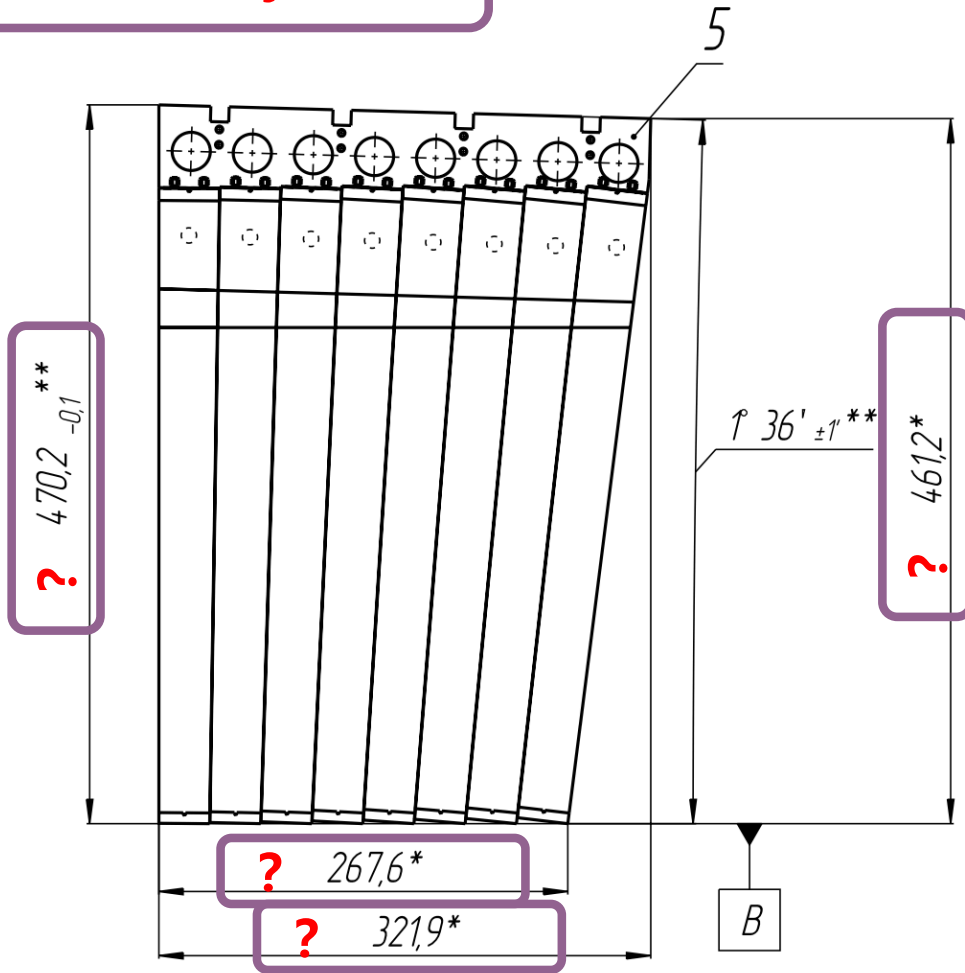

X-ray test results | Waveform / Wave data / Peak / Integral



Tower Information — Four parameters

? Assembly time

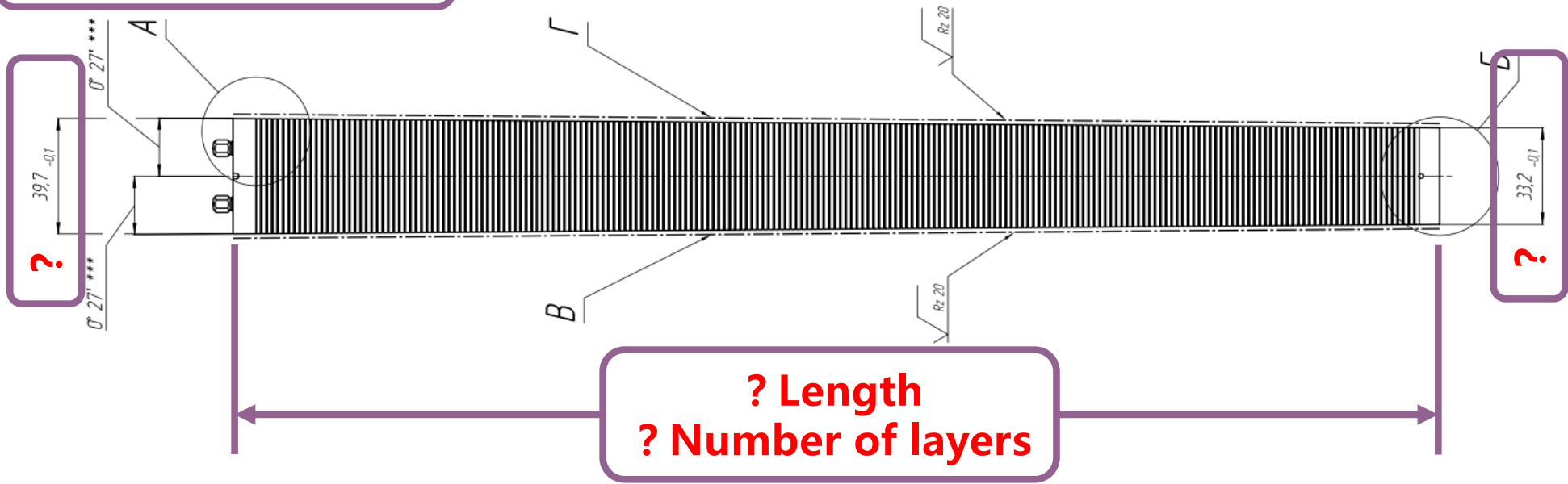

Cosmic ray test results	Waveform / Wave data / Peak / Integral
X-ray test results	Waveform / Wave data / Peak / Integral

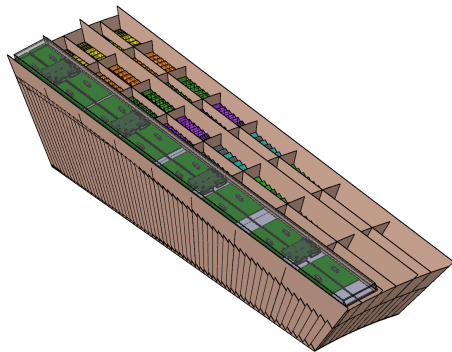

X 4 = 2 sectors

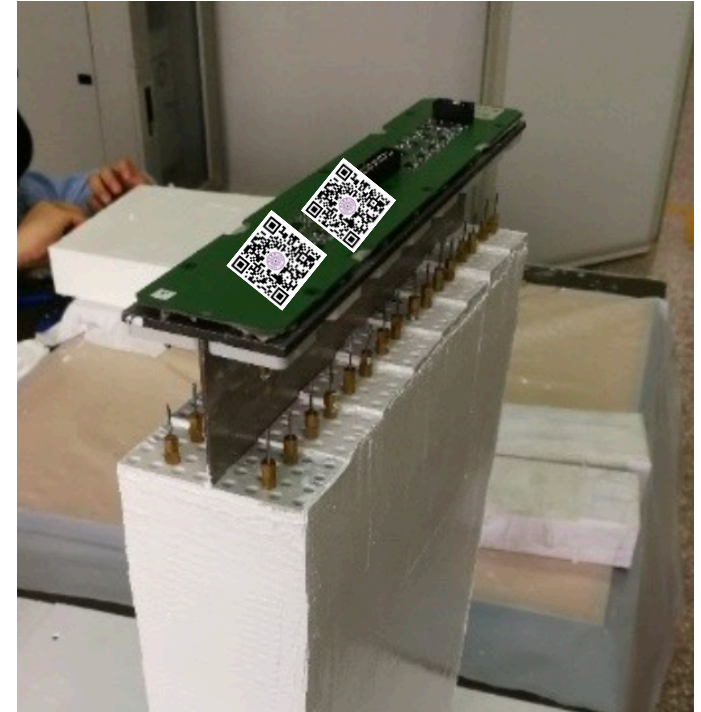

Zone 1	Zone 2	Zone 3	Zone 4	Zone 5	Zone 6	Zone 7	Zone 8
--------	--------	--------	--------	--------	--------	--------	--------

Module 1	Module 1
Module 2	Module 2
...	...
Module 24	Module 24



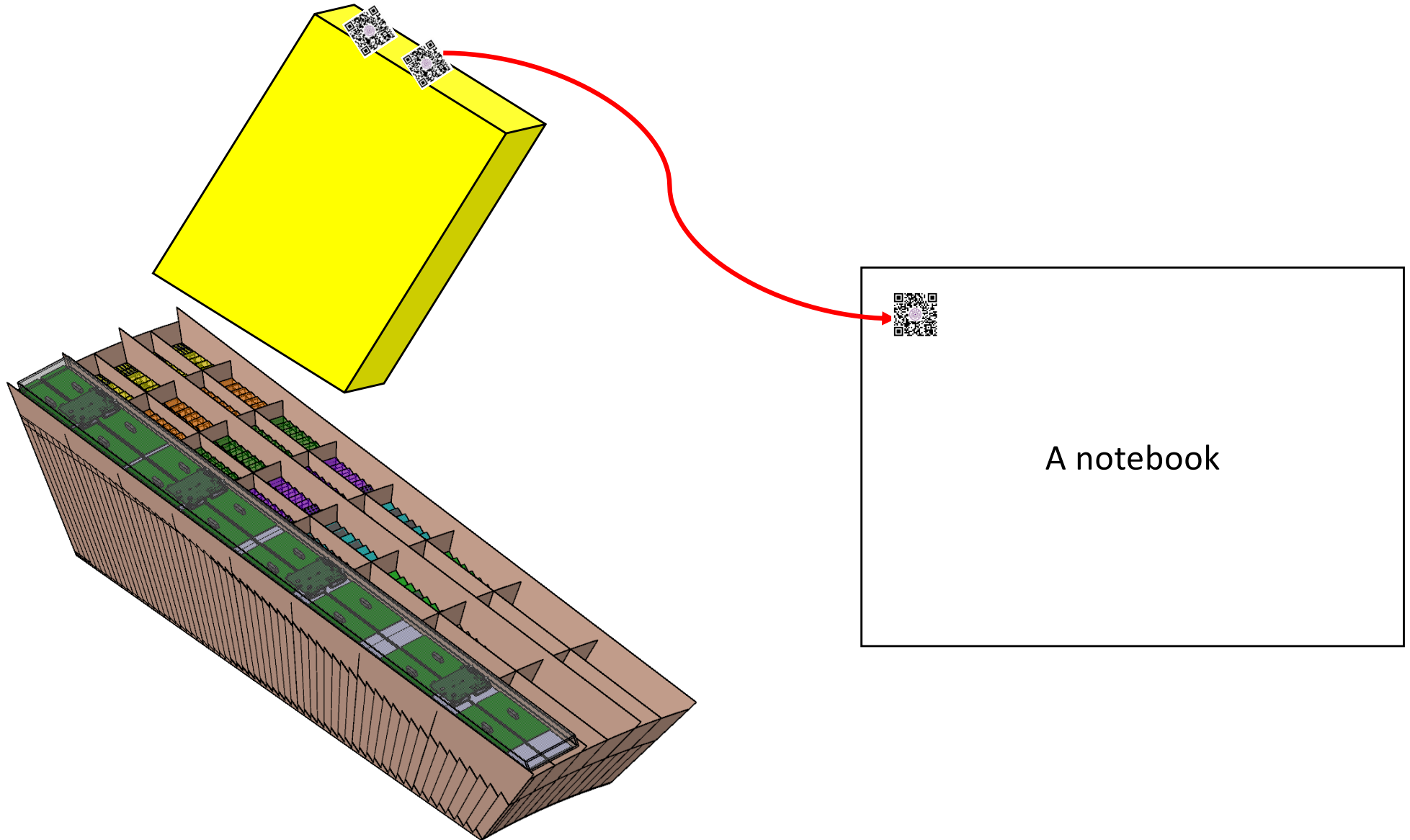



 8-2	 7-2	 6-2	 5-2	 4-2	 3-2	 2-2	 1-2	 1-1	 2-1	 3-1	 4-1	 5-1	 6-1	 7-1	 8-1
 8-4	 7-4	 6-4	 5-4	 4-4	 3-4	 2-4	 1-4	 1-3	 2-3	 3-3	 4-3	 5-3	 6-3	 7-3	 8-3
 8-6	 7-6	 6-6	 5-6	 4-6	 3-6	 2-6	 1-6	 1-5	 2-5	 3-5	 4-5	 5-5	 6-5	 7-5	 8-5
 8-8	 7-8	 6-8	 5-8	 4-8	 3-8	 2-8	 1-8	 1-7	 2-7	 3-7	 4-7	 5-7	 6-7	 7-7	 8-7
 8-10	 7-10	 6-10	 5-10	 4-10	 3-10	 2-10	 1-10	 1-9	 2-9	 3-9	 4-9	 5-9	 6-9	 7-9	 8-9
 8-12	 7-12	 6-12	 5-12	 4-12	 3-12	 2-12	 1-12	 1-11	 2-11	 3-11	 4-11	 5-11	 6-11	 7-11	 8-11



清华大学
TSINGHUA UNIVERSITY

Thanks for your attention!

Yulei Li

Department of Engineering Physics, Tsinghua University, Beijing, China